

C2

IMAGING

*A Vomela
Affiliated Company*

2018



MODULAR AND CUSTOM EXHIBIT SOLUTIONS

Crown Molding

Finish off any pillow case box shape with our crown molding for a tight, architectural look.

Dimensional Logos

Dimensional logos have never been easier. Each component just clicks into place - ask about our LED edge lighting for more POP!!!

Artwork

Framed artwork or just printed sintra - you can organize an eye-catching grid that adds that home decor look to any wall.

Kickplates

Much like our crown molding these kickplates give any box shape a tight, finished look.





Klik™ Accessories

This is where Klik™ shines! Use our accessories to display and promote your products and services. Interchange as necessary.

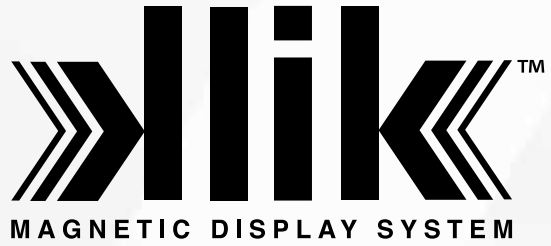

Side Walls

We use Klik™ for much more than sticking things to the surface - we connect walls to each other eliminating the need for bolts and hard-to-reach zippers.



Klik™ Magic Podium

This podium ships with the graphic attached and you simply just lift it in place!

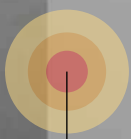



 **Klik™ Magic Podium**

When you see this podium in action you'd swear it was magic! What we love most about our Klik™ Magic Podium is that the quality of this product is so good it will probably replace our existing rectangle podium. When it's flat, it's only 4" thick and will fit in our standard case or in a canvas bag. Easily setup by just 1 person in seconds!



 **Klik™ Crown Molding and Kickplates**

Our Klik™ Crown Molding and Kickplates were invented because of our pursuit of creating products that look "finished." Add these to any tension fabric box structure for a classy architectural look that will provide that "finished" look you've always wanted.

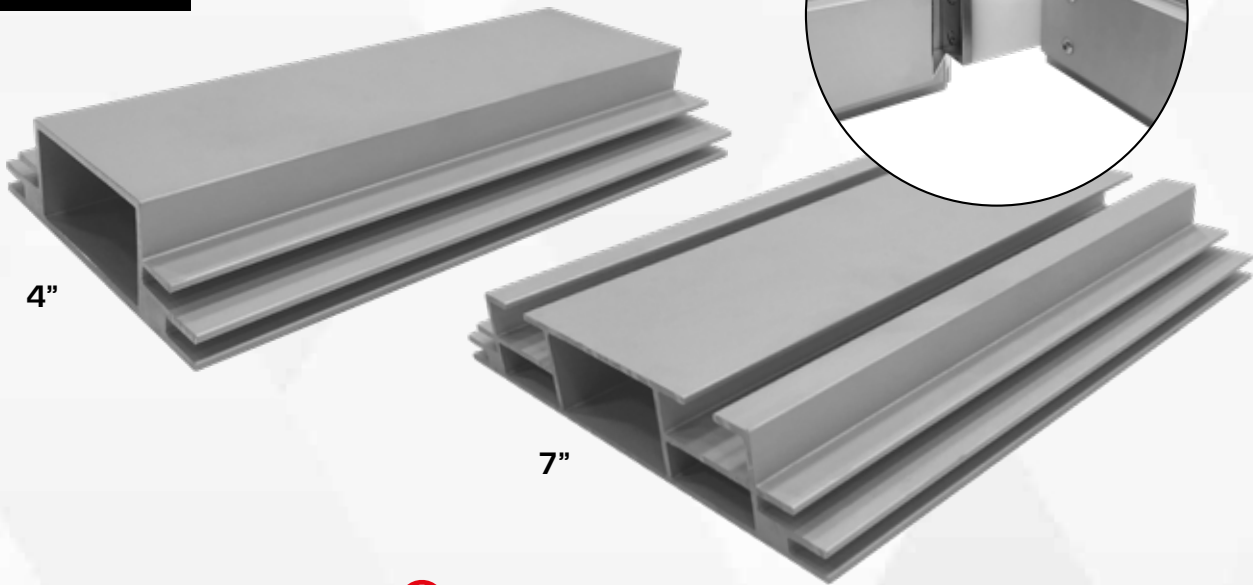
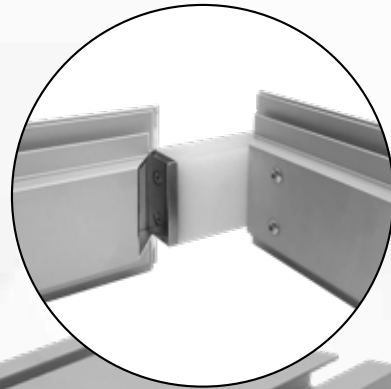

 **Klik™ SEG Extrusions**

Cut your setup time for SEG frames by 75% - our Klik™ SEG Extrusions will save you time and money. With interchangeable magnetic corner connectors these frames go together in minutes. With our new support feet the entire box goes together without tools!



 **NO TOOLS SUPPORT FEET**

It can be frustrating when attaching support feet takes longer than setting up the entire tension fabric wall. Our new support feet slide right on and with a 90° turn - lock into place. Just another example of how we make your life easier when setting up your booth.

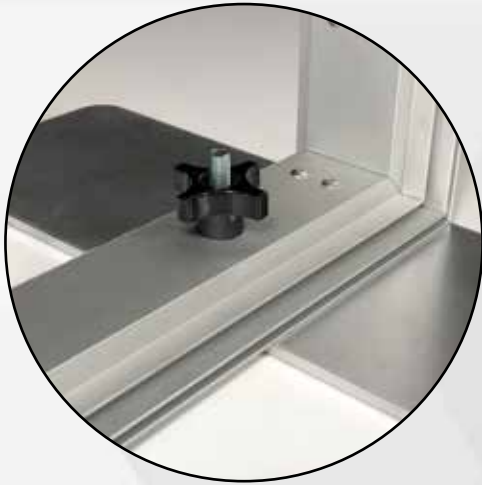
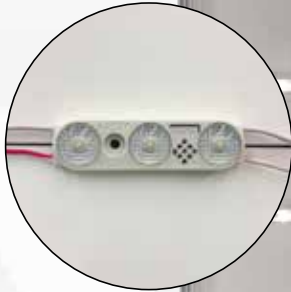

No Tools Assembly

Our new Klik™ extrusions require NO TOOLS to assemble and that includes the support feet. With a registration pin and knob it's never been easier to assemble our SEG frames - just Klik™ together and attach the feet!



LoPro Magic Frame
Single-Sided

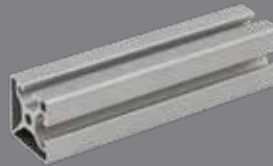

Rigid Slot
2 Sided

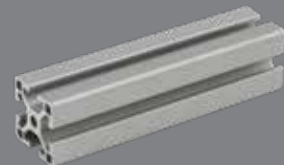

Rigid Slot
4-Sided

Extrusions for Graphic Displays

We have a wide variety of aluminum extrusions for dye sub prints with silicone edging (SEG). Single-sided and double-sided options make these extrusions a great choice for wall mounted or hanging displays. Rigid Slot is great for acrylic or sintra printed pieces.

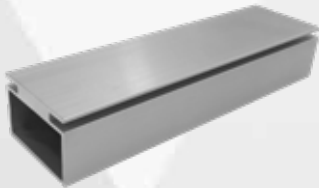
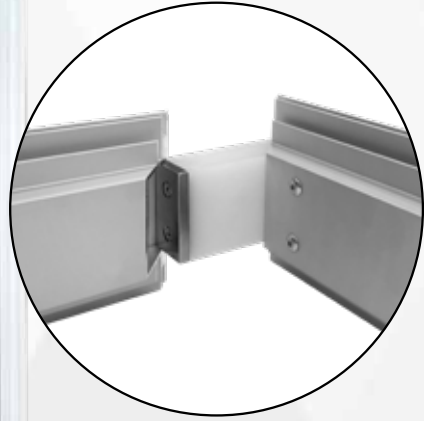

2" Klik™ SEG Frame - Double Sided

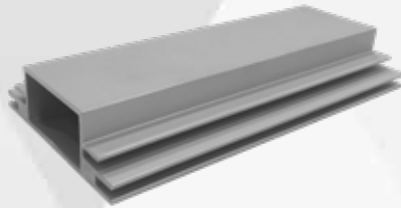

4" Klik™ SEG Frame - Double Sided

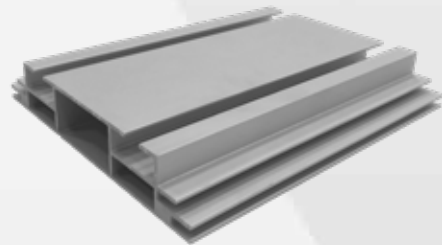

7" Klik™ Frame - Double Sided

Klik™ SEG Light Wall Extrusions

Our Klik™ SEG Light Wall is the easiest way to add extra punch to any trade show display or exhibit. Our Klik™ Frame goes together quickly and the bright LED lights ensure that your image will Pop! Single-sided options can mount to walls and the double-sided works great with feet. Big or small - custom sizes are no problem.



The Ultimate in Flexibility and Visual Impact

The NEW Klik™ Display System is the perfect solution for displaying products in trade show or exhibit environments. The lightweight aluminum frames and tension fabric are incredibly easy to set up. Now you can add a variety of components to display your products just by “Klik-ing” them in place! There are no holes in the fabric and with our grid system you can switch layouts whenever you feel like it. Powerful magnets are at the core of Klik™ and when you see the display in action you’d swear it was magic!



Klik™ Assembly



Klik™ Assembly

The Klik™ Assembly can be added to any flat tension fabric structure. If you have something specific in mind and need more assemblies added to your booth - no problem! Let us know how we can help you take advantage of the Klik™ Display System to enhance your trade show or exhibit presence.



Klik™ is utilized anywhere we can help save time and to make things easy. Side walls are connected with Klik™ eliminating zippers, bolts and wing-nuts. You'll find that Klik™ was designed to make your life easier and we think you'll love it!



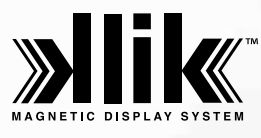

Klik™ CROWN MOLDING & KICKPLATES

Our Klik™ Molding options give you that finished look for tension fabric box shapes. Our magnetic system makes these the perfect fit for towers, boxes, podiums, counters and other elements.

Kickplates: 5.5" Tall Crown Molding: 4" Tall

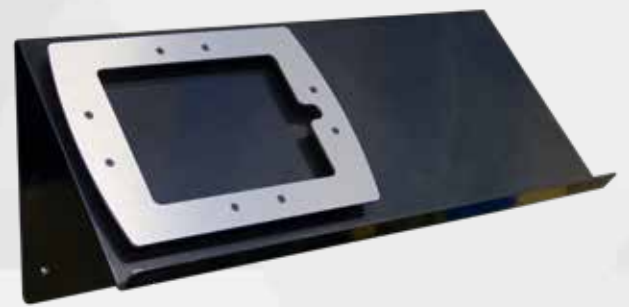

Klik™ Acrylic Tilted Display Shelf | Tilted Acrylic iPad Shelf

Tilted shelves are great for brochures and other printed literature. With the addition of the iPad holder you can add kiosk functionality or videos for an interactive experience.

Display Size: 23.5"W x 10"H x 8.25"D



Klik™ Single or Double Shelf

Shelving was never easier! These sleek shelves feature a graphic insert (acrylic or sintra printed) and provide a creative way to brand your company or products.

Display Size: 23.5"W x 9.5"H x 10"D



Klik™ Sintra Graphics

The assorted sizes for the Klik™ Graphics provide a vast array of options for your display requirements. Made to fit perfectly with the Klik™ Grid System - everything goes exactly where it's supposed to for a perfect look every time.

Small: 23.5"W x 9.25"H

Medium: 23.5"W x 16.75"H

Large: 23.5"W x 31.75"H



YOUR BUSINESS IS UNIQUE AND YOUR BOOTH SHOULD REFLECT THAT.





Utilize our team of craftsmen and designers to customize a booth that accomplishes your goals. Everything we make can be tweaked or designed for you or your customers. Just ask.





YOUR BUSINESS IS UNIQUE AND YOUR BOOTH SHOULD REFLECT THAT.





Utilize our team of craftsmen and designers to customize a booth that accomplishes your goals. Everything we make can be tweaked or designed for you or your customers. Just ask.





YOUR BUSINESS IS UNIQUE AND YOUR BOOTH SHOULD REFLECT THAT.





Utilize our team of craftsmen and designers to customize a booth that accomplishes your goals. Everything we make can be tweaked or designed for you or your customers. Just ask.





Slider

- Standard Sizes
- 8' h x 10' w
 - 8' h x 20' w



Axis

- Standard Sizes
- 8' h x 8' w
 - 8' h x 10' w



Wave

- Standard Sizes
- 8' h x 10' w



Flat

- Standard Sizes
- 8' h x 10' w
 - 8' h x 20' w



Scoop

- Standard Sizes
- 8' h x 10' w
 - 8' h x 20' w



Crescent

- Standard Sizes
- 8' h x 10' w
 - 8' h x 20' w



Center Arch

- Standard Sizes
- 8' h x 10' w
 - 8' h x 20' w

WE MANUFACTURE CUSTOM SIZES AND SHAPES



S-Wall

Standard Sizes
• 8' h x 20' w x



Tapered Crescent

Standard Sizes
• 8' h x 10' w



L-Wall

Standard Sizes
• 8' h x 10' w



Half-Pipe

Standard Sizes
• 8' h x 10' w



Half-Wall

Standard Sizes
• 4' h x 10' w



Flat

Standard Sizes
• 8' h x 3' w
• 8' h x 5' w
• 8' h x 10' w



Pie

Standard Sizes
• 8' h x 3' w



LED Clamp Light

High Quality LED
Works with any of our
FORMZ Frames!

WE MANUFACTURE CUSTOM SIZES AND SHAPES



Flat Stand-Off

- Standard Sizes
- 8' h x 18" to 36" w
 - 9' h x 18" to 36" w
 - 10' h x 18" to 36" w



Pie Stand-Off

- Standard Sizes
- 8' h x 18" to 36" w
 - 9' h x 18" to 36" w
 - 10' h x 18" to 36" w



Photo Stand-Off

- Standard Sizes
- 8' h x 18" to 36" w
 - 9' h x 18" to 36" w
 - 10' h x 18" to 36" w



Shelf Stand-Off

- Standard Sizes
- 8' h x 18" to 36" w
 - 9' h x 18" to 36" w
 - 10' h x 18" to 36" w



Circle Podium

- Standard Sizes
- 42" h x 24" w x 24" d



Oval Podium

- Standard Sizes
- 42" h x 40" w x 21" d



Square Podium

- Standard Sizes
- 42" h x 24" w x 24" d



Rectangle Podium

- Standard Sizes
- 42" h x 40" w x 21" d



Half-Moon Podium

- Standard Sizes
- 42" h x 60" w x 21" d



Crescent Podium

- Standard Sizes
- 42" h x 70" w x 18" d



Crescent Counter

- Standard Sizes
- 42" h x 100" w x 18" d



Round Counter

- Standard Sizes
- 42" h x 90" w x 18" d



Triple Band

Standard Sizes

- 3' h x 8' w x 8' d
- 4' h x 10' w x 10' d
- 5' h x 12' w x 12' d



Tapered Circle

Standard Sizes

- 2' h x 6' w x 6' d
- 3' h x 8' w x 8' d
- 3.5' h x 10' w x 10' d
- 4' h x 12' w x 12' d



Split Tapered Circle

Standard Sizes

- 2' h x 6' w x 3' d
- 3' h x 8' w x 4' d
- 3.5' h x 10' w x 5 d



Circle Disk

Standard Sizes

- 4' h x 4' w
- 6' h x 6' w
- 8' h x 8' w



Square

Standard Sizes

- 2' h x 6' w x 6' d
- 3' h x 8' w x 8' d
- 3.5' h x 10' w x 10' d
- 4' h x 12' w x 12' d



Tapered Square

Standard Sizes

- 2' h x 6' w x 6' d
- 3' h x 8' w x 8' d
- 3.5' h x 10' w x 10' d
- 4' h x 12' w x 12' d



Circle

Standard Sizes

- 2' h x 6' w x 6' d
- 3' h x 8' w x 8' d
- 3.5' h x 10' w x 10' d
- 4' h x 12' w x 12' d



Oval Disk

Standard Sizes

- 3' h x 5' w
- 4' h x 8' w
- 5' h x 10' w



Wave

Standard Sizes

- 3' h x 8' w x 1' d
- 4' h x 10' w x 2' d
- 5' h x 12' w x 3' d



Double Band

Standard Sizes

- 3' h x 8' w x 2' d
- 4' h x 10' w x 3' d
- 5' h x 12' w x 4' d

WE MANUFACTURE CUSTOM SIZES AND SHAPES



Round
Standard Sizes
• 8' h x 6' d



Tapered Round
Standard Sizes
• 8' h x 6' d



Tall
Standard Sizes
• 12' h x 6' d



Square
Standard Sizes
• 10' h x 36" d at base
• 12' h x 36" d at base
• 15' h x 48" d at base



Tapered Square
Standard Sizes
• 10' h x 24" sq. at base
• 12' h x 24" sq. at base
• 15' h x 36" sq. at base



Round
Standard Sizes
• 10' h x 36" d at base
• 12' h x 36" d at base
• 15' h x 48" d at base



Tapered Round
Standard Sizes
• 10' h x 24" d at base
• 12' h x 24" d at base
• 15' h x 36" d at base



ION

Standard Sizes

- 72" h x 42" w x 8" d
- 84" h x 42" w x 8" d
- 96" h x 42" w x 8" d



Axis

Standard Sizes

- 8' h x 8' w
- 8' h x 10' w



**Crescent
w/Shelves**

Standard Sizes

- 60" h x 42" w x 12" d
- 72" h x 42" w x 12" d



Crescent TV Stand

Standard Sizes

- 60" h x 42" w x 18" d
- 72" h x 42" w x 18" d



Blade Display

Standard Sizes

- 84" h x 30" w x 24" d



Standee

- 72" h x 36" w x 18" d



Flex Display

Standard Sizes

- 68" h x 28" w x 16" d





Small Storage Case
Outside: 16"W x 51"H x 16"D
Inside: 14"W x 48"H x 14"D



Medium Storage Case
Outside: 22.5"W x 51"H x 14"D
Inside: 18"W x 48"H x 13"D



Large Storage Case
Outside: 27.5"W x 55"H x 10-17"D
Inside: 24"W x 52"H x 9-16"D

C2

IMAGING

*A Vomela
Affiliated Company*

WWW.C2IMAGING.COM